

User Guide



7/9" Dual-Screen DVD Player

NS-MVDS7/9

Insignia NS-MVDS7/9 7/9" Dual-Screen DVD Player

Contents

Welcome	3
Safety information	3
Features	7
Setting up your player	12
Using your player	19
Maintaining	40
Troubleshooting	41
Specifications	42
Legal notices	43
One-year limited warranty	45

Welcome

Congratulations on your purchase of a high-quality Insignia product. Your NS-MVDS7/9 represents the state of the art in dual-screen DVD player design and is designed for reliable and trouble-free performance.

Safety information



The lightning flash with arrowhead symbol within a triangle is intended to alert you to the presence of uninsulated dangerous voltage within your player's enclosure that may be of sufficient magnitude to constitute risk of electric shock to persons.



The exclamation point within a triangle is intended to alert you to the presence of important operating and maintenance (servicing) instructions in the literature accompanying your player.

Warning

Replace the remote control battery only with the same or equivalent type. Replacing the battery incorrectly can be hazardous. In order to protect the environment, dispose of the battery as hazardous waste.

Warning

To reduce the risk of fire or electric shock, do not expose this player to rain or moisture. Dangerous high voltage is present inside the enclosure. Do not open the case.

Warning

To prevent electric shock, match the wide blade on the plug to the wide slot and fully insert the plug.

Warning

Your player employs a laser system. To ensure the proper use of your player, read this manual carefully and keep it for future reference. If your player requires servicing, contact the seller or our service center.

To prevent direct exposure to the laser radiation, do not open the case. Invisible laser radiation is present when the case is opened or the interlocks are defeated. Do not stare into the laser beams.

Use of any controls, adjustments, or procedures other than those specified herein may result in hazardous radiation exposure.

Caution

Any change or modification to your player not expressly approved by the manufacturer or its authorized parties could void your authority to operate your player.

Specific instructions

- **Read instructions**—Read all the safety and operating instructions before operating your player.
- **Retain instructions**—Retain the safety and operating instructions for future reference.
- **Warnings**—Adhere to all warnings on your player and in the operating instructions.
- **Follow instructions**—Follow all operating and use instructions.

- **Cleaning**—Unplug this player from the power outlet before cleaning. Do not use liquid cleaners or aerosol cleaners. Use a damp cloth for cleaning.
- **Handling**—Take care not to drop your player or subject it to strong shocks, which may cause damage or malfunction.
- **Attachments**—Use of attachments not recommended by your player manufacturer may cause hazards.
- **Using headphones:**
 - To avoid hearing damage caused by a sudden increase in volume, keep the volume at the lowest level before playback, then adjust it to a comfortable level.
 - Keep the volume at a moderate level to protect your ears.
 - To avoid traffic accidents, never wear headphones when driving a car or riding a bicycle.
- **Maintenance**—If you move your player from a cold place to a warm one or use your player in a humid area, your player may experience condensation. If this occurs, remove the disc and leave your player on for about one hour to let the condensation evaporate.
- **Placement**—Avoid placing your player in the following places:
 - Under direct sunlight or near a source of heat, such as a heater or header duct.
 - In a closed automobile, on a dashboard or a parcel shelf. Excess heat may deform the cabinet or cause malfunction.
 - Where it is very dusty or sandy.
 - In wet or humid places, such as a bathroom.
 - Near sources of strong magnetism, such as a television or a magnet.
 - Where there is a lot of movement or vibration, such as on a car dashboard or on an unstable shelf.
 - Where it is extremely hot or cold.
 - Where your player is exposed to rain or water.
- **Power sources**—Your player operates on an AC adapter or vehicle adapter.
 - The main plug is the disconnecting device. The plug must remain readily operable.
 - Make sure that the input voltage of the AC adapter is compatible with the local voltage. Otherwise, the AC adapter and your player may be damaged.

Warning

To avoid electric shock, do not touch the AC adapter with wet hands.

- When connecting with a vehicle (cigarette lighter) adapter, be sure the input voltage of the adapter is identical with vehicle voltage.

- Unplug the AC adapter from the outlet when your player will not be used for an extended period of time.
- Hold the plug while unplugging the AC adapter. Do not pull on the power cord.
- **Grounding or polarization**—This player may be equipped with a polarized alternating-current line plug (a plug having one blade wider than the other). This plug will only fit into the power outlet one way. This is a safety feature. If you are unable to insert the plug fully into the outlet, try reversing the plug. If the plug still fails to fit, contact your electrician to replace your obsolete outlet. Do not defeat this safety feature of the polarized plug.
- **Power cord protection**—Power supply cords should be routed so that they are not likely to be walked on or pinched by items placed on or against them. Pay particular attention to cords at plugs, receptacles, and the point where they exit from your player.
- **Lightning**—For added protection during a lightning storm, or when your player is left unattended and unused for long periods of time, unplug it from the power outlet. This will prevent damage to your player due to lightning and power-line surges.
- **Overloading**—Do not overload power outlets, extension cords, or integral convenience receptacles as this can result in a risk of fire or electric shock.
- **Object and liquid entry**—Never push objects of any kind into this player. That could cause a fire or electric shock. Never spill liquid of any kind on your player.
- **Servicing**—Do not try to service this player yourself. Your player uses a laser that can damage your eyes. Service must be done by qualified service personnel only.
- **Damages requiring service**—Unplug this player from the power outlet and refer servicing to qualified service personnel under the following conditions:
 - When the power supply cord or plug is damaged.
 - If liquid has been spilled, or objects have fallen into your player.
 - If your player has been exposed to rain or water.
 - If your player does not operate normally by following the operating instructions. Adjust only those controls that are covered by the operating instructions. The improper adjustment of other controls may result in damage and will often require extensive work by a qualified technician to restore your player to its normal operation.
 - If your player has been dropped or damaged in any way.
 - When your player exhibits a distinct change in performance which may indicate a need for service.

- **Replacement parts**—When replacement parts are required, be sure the service technician uses replacement parts that are specified by the manufacturer or that have the same characteristics as the original part. Unauthorized substitutions may result in fire, electric shock, or other hazards.
- **Safety check**—Upon completion of any service or repair to this player, ask the service technician to perform safety checks to determine that your player is in proper operating condition.
- **Stand**—Do not place your player on an unstable cart, stand, tripod, bracket, or table. Your player may fall, causing serious personal injury and serious damage to your player. Use only with a cart, stand, tripod, bracket, or table recommended by the manufacturer, or sold with your player.
- **TFT LCD**—During playback, a few bright or dark flecks may appear on the TFT LCD. This is normal in active matrix display technology and is not a malfunction.

Features

Large content displays—Includes a 7" or 9" TFT wide-screen LCD display (depending on the model) for a cinematic video experience.

High resolution panels—Adopt MPEG-2 encoding format and brings the horizontal resolution to over 500 lines.

Compatibility—Plays DVDs and CDs.

Parental lock—Makes it easy to control the content of the discs.

Convenient multi-function remote—Provides useful functions, such as fast forward, fast reverse, slow play, and repeat play at the touch of the fingertip.

Zoom function—Enlarge pictures 2x, 3x, or 4x, or shrink to 1/2, 1/3, or 1/4 of the original size.

Time search—Locates a specific section of a disc. This feature is especially good for watching action movies.

Multi-language on-screen display (OSD)—Lets you select English, French, or Spanish for use in OSD menus.

Audio output—Provides analog audio output connections so you can connect your player to an amplifier for higher quality sound.

Player

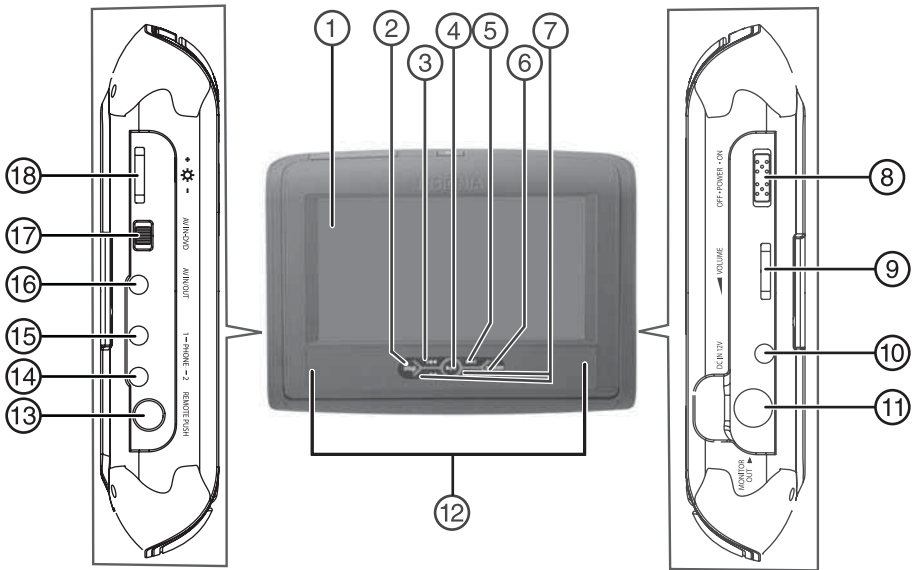

No.	Component	Description
1	TFT LCD	Displays the DVD image and on-screen display (OSD).
2	STOP button	Press to stop disc playback.
3	PREV button	Press to go to the previous DVD chapter or CD track.
4	PLAY/PAUSE button	Press to start or pause disc playback.
5	NEXT button	Press to go to the next DVD chapter or CD track.
6	SCREEN button	Press to switch the aspect ratio between Normal 4:3 and Wide 16:9.
7	◀◀ ▶▶	Press to search backward or forward on a disc.
8	POWER switch	Slide to turn your player on and off.
9	VOLUME knob	Rotate to adjust the volume.
10	DC IN 12 V	Connect the AC power adapter here.
11	MONITOR OUT	Provides power and AV signal to the extra monitor.
12	Speakers	Provide audio output when the headphones are not plugged in.
13	Remote push	Push to eject the remote control from the player.
14	PHONE 2	Plug a second set of headphones into this jack.
15	PHONE 1	Plug a set of headphones into this jack.

No.	Component	Description
16	AV IN/OUT	Plug the mini-AV connector on the AV cable into this jack. Plug the other end into an external audio/video device.
17	AV IN-DVD switch	Set this switch to DVD to display the program from this player. Set the switch to AV IN to display the program from an external device.
18	BRIGHTNESS control	Rotate to adjust the screen brightness.

Extra monitor

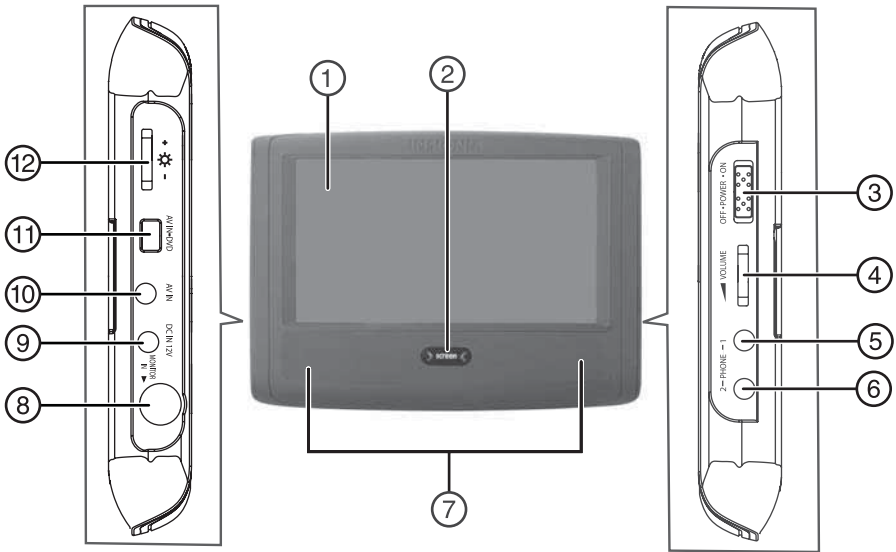

No.	Component	Description
1	TFT screen	Displays the DVD image and on-screen display (OSD).
2	SCREEN button	Press to switch the aspect ratio between Normal 4:3 and Wide 16:9.
3	POWER switch	Slide to turn the monitor on and off.
4	VOLUME knob	Rotate to adjust the volume.
5	PHONE 1	Plug a set of headphones into this jack.
6	PHONE 2	Plug a second set of headphones into this jack.
7	Speakers	Provide audio output when the headphones are not plugged in.
8	MONITOR IN	Receives power and AV signal from the main unit.
9	DC IN 12 V	Plug the AC adapter into this jack.
10	AV IN	Plug the mini connector on the AV cable into this jack. Plug the other connectors into the audio/video jacks on an external audio/video device to show the picture from the external device.
11	AV IN-DVD switch	Set this switch to DVD to display the program from the DVD player. Set the switch to AV IN to display the program from an external device (If there is an AV device connected to the AV IN jack).
12	BRIGHTNESS	Rotate to adjust the screen brightness.

Remote control

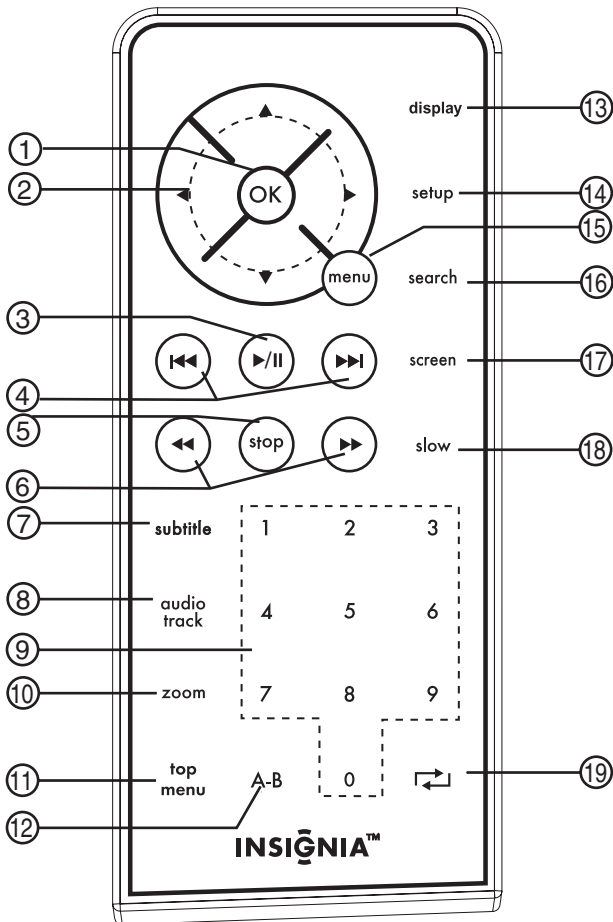

No.	Button	Description
1	OK	Press to confirm selections in the OSD.
2	▶ ◀ ▲ ▼ (Direction buttons)	Press to make selections in the OSD.
3	▶ / (Play/Pause)	Press to start or pause disc playback.
4	▶▶▶ (Next) ◀◀◀ (Previous)	Press to go to the next or previous DVD chapter or CD track.
5	STOP	Press to stop disc playback.

No.	Button	Description
6	◀◀ (Fast-reverse) ▶▶ (Fast-forward)	Press to fast-forward or fast-reverse on a DVD or CD.
7	SUBTITLE	Press to turn DVD subtitles on or off.
8	AUDIO TRACK	Press to select the DVD audio language if the DVD has multiple audio languages.
9	Number buttons	Press to select DVD chapters and titles or CD tracks. In the OSD, press to enter your password.
10	ZOOM	Press to change the image size.
11	TOP MENU	When a DVD menu is open, press to return to the title menu.
12	A-B	Press to create a playback loop.
13	DISPLAY	Press while a disc is playing to open the On Screen Display (OSD), containing many playback features.
14	SETUP	Press to open the SETUP MENU.
15	MENU	Press to open the DVD menu.
16	SEARCH	Press to search on a DVD or CD.
17	SCREEN	Press to switch the aspect ratio between Normal 4:3 and Wide 16:9.
18	SLOW	Press to play a DVD in slow-motion.
19	↺ (Repeat)	Press to repeat a DVD chapter, CD track, or an entire disc.

Setting up your player

Package contents

Make sure the package contains the following items:

- DVD player and extra monitor
- A/V cable
- Remote control with battery installed
- User guide
- AC power adapter
- Vehicle cigarette lighter adapter
- Power/AV cable

Using the remote control

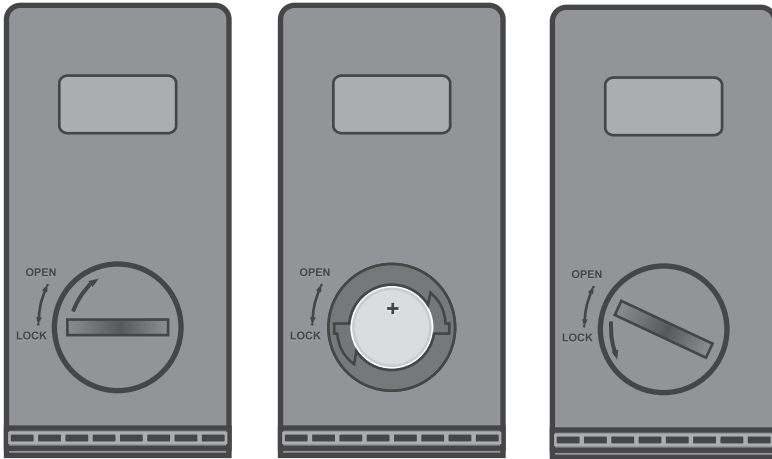

To use the remote control:

- 1 Turn the remote control over.
- 2 Using a coin, remove the battery compartment cover on the remote control by rotating it 1/8 turn clockwise.
- 3 Insert the battery (provided) into the battery compartment. Make sure that the (+) and (-) symbols on the battery match the diagram inside the compartment.
- 4 Using the coin, close the compartment by rotating the cover 1/8 turn counterclockwise.
- 5 To use the remote control, point it at the player's remote sensor. (Operate in the range of 16 feet (5 meters) and 30°.)

Tips

Generally, batteries last for about one year. Replace the batteries if the remote control does not work.

Remove the batteries if the remote control will not be used for an extended period of time.

Connecting the AC adapter and extra monitor

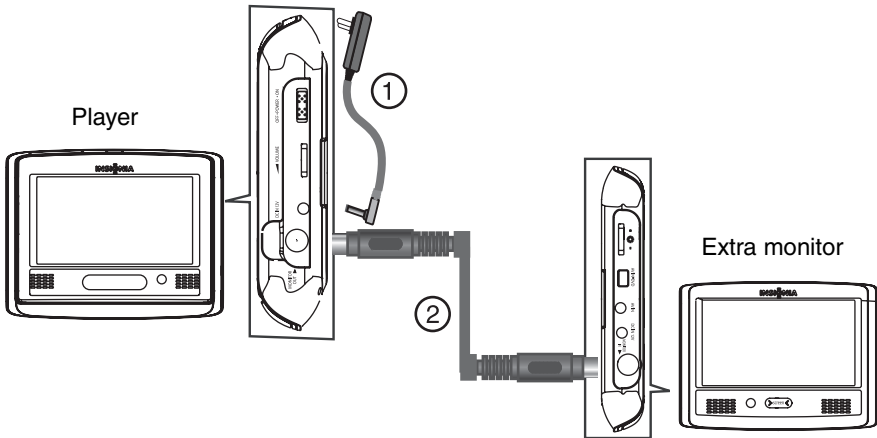

To connect the AC adapter and extra monitor:

- 1 Plug the AC adapter plug (1) into an AC power outlet, then connect it to the **DC IN 12 V** jack on the player.
- 2 Plug the Power/AV cable (2) into the **MONITOR OUT** jack on the player, then plug it into the **MONITOR IN** jack on the extra monitor.

Connecting the vehicle adapter and extra monitor

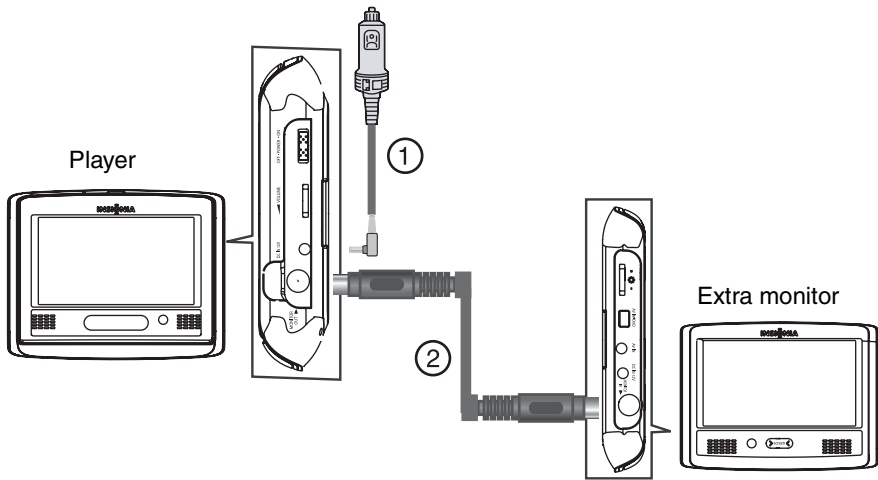

To connect the vehicle adapter and extra monitor:

- 1 Plug the vehicle adapter plug (1) into a vehicle cigarette lighter, then connect it to the **DC IN 12 V** jack on the player.
- 2 Plug the Power/AV cable (2) into the **MONITOR OUT** jack on the player, then plug it into the **MONITOR IN** jack on the extra monitor.

Connecting the headphones

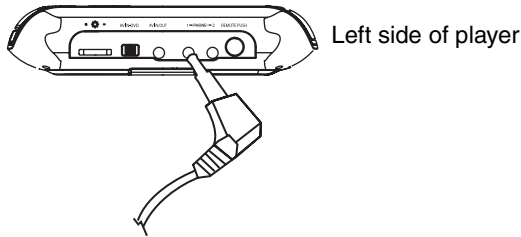

To connect the headphones:

- 1 Turn off your player.
- 2 Plug the headphones into one of the **PHONE** jacks on the left side of your player or the right side of the extra monitor.

Caution

Always turn off your player before you connect or disconnect the headphones. Failure to do so could result in damage to your player.

Connecting your player to a TV

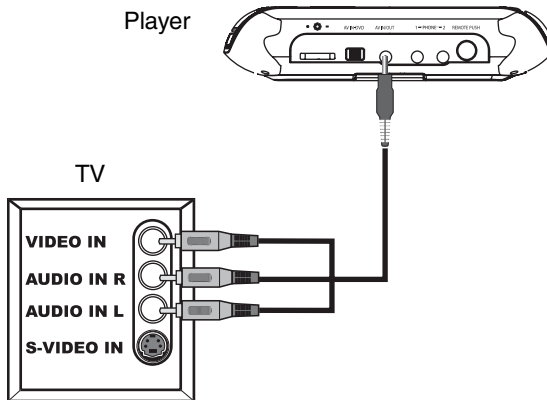

To connect your player to a TV:

- 1 Plug the mini AV connector into the **AV IN/OUT** jack on the left side of your player.
- 2 Plug the yellow connector into the **VIDEO IN** jack on your TV.

- 3 Plug the red and white connectors into the **AUDIO R** and **AUDIO L IN** jacks, respectively, on your TV.

Tip

When connecting your player to a TV, set the AV IN-DVD switch on the left side of the player to DVD.

Connecting your player to a TV and amplifier

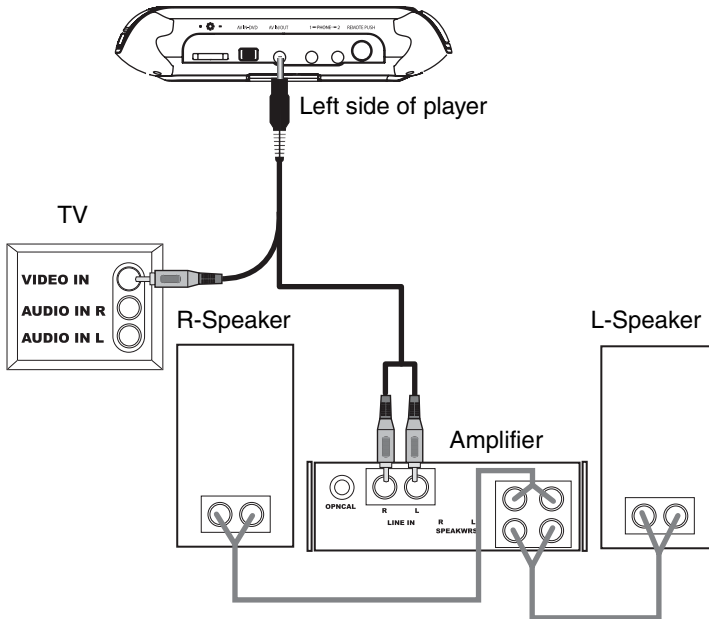

To connect your player to a TV and amplifier:

- 1 Plug the mini AV connector into the **AV IN/OUT** jack on the left side of your player.
- 2 Plug the yellow connector into the **VIDEO IN** jack on your TV.
- 3 Plug the red and white connectors into the **AUDIO R** and **AUDIO L IN** jacks, respectively, on your amplifier.

Tip

When connecting your player to a TV or amplifier, set the **AV IN-DVD** switch on the left side of the player to **DVD**.

Mounting your player and extra monitor in a vehicle

To mount your player and extra monitor in a vehicle:

- 1 Attach the mounting belts to your player and extra monitor according to the following illustrations.

NS-MVDS7



NS-MVDS9





- 2 Strap your player and extra monitor over your vehicle seats headrests as shown in the following illustration.

**Tip**

While your player is being used in your vehicle, be sure it is safely secured and does not obstruct safety devices like air bags or seat belts.

Using your player

Playable discs

Type	Disc logo	Content	Size	Playing time
DVD		Audio and video (motion pictures)	12 cm	About 2 hours (single side disc) About 4 hours (double-side disc)
			8 cm	About 80 minutes (single side disc) About 160 minutes (double-side disc)
CD		Audio	12 cm	About 74 minutes
			8 cm	About 20 minutes

Turning your player and monitor on and off

To turn your player and extra monitor on and off:

- 1 Slide the **POWER** switch on your player and monitor to the **ON** position to turn it on.
- 2 Slide the **POWER** switch on your player and monitor to the **OFF** position to turn it off.

Playing a disc

To play a disc:

- 1 Turn on your player.
- 2 Press **PUSH** to open the disc tray.

PUSH to open



- 3 Place the disc, label side up, into the disc tray.
- 4 Press the disc tray cover down to close the tray.
- 5 Press ► / || to start disc playback.

Controlling disc playback

To control disc playback:

- To pause playback, press ► / ||. To resume playback, press ► / || again.
- To stop playback, press **STOP** twice.
- To fast-reverse or fast-forward, press ◀◀ or ▶▶. Each time you press one of these buttons the fast-reverse or fast-forward speed changes from 2x to 4x to 8x to 16x to 32x. Press ► / || to return to normal playback.
- To play a DVD in slow-motion, press **SLOW**. Each time you press the button the slow-motion speed changes from 1/2x to 1/4x to 1/8x to 1/16x. Press ► / || to return to normal playback.

Adjusting the picture

To adjust the picture:

- Rotate the **BRIGHTNESS** control on your player or monitor to adjust the brightness.

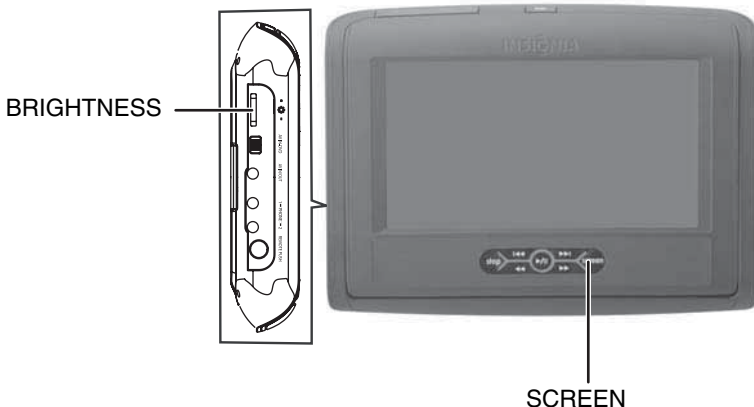

- Press **SCREEN** to select the aspect ratio of the picture. Choices include **Normal 4:3** and **Wide 16:9**.

Adjusting the volume

To adjust the volume:

- Rotate the VOLUME control to adjust the volume.

Using a DVD menu

Some DVDs have menus that let you select a title or chapter on the DVD.

To select a title or chapter from the DVD menu:

- 1 Put the DVD in the player.
- 2 Press ► / ||. The root menu opens.

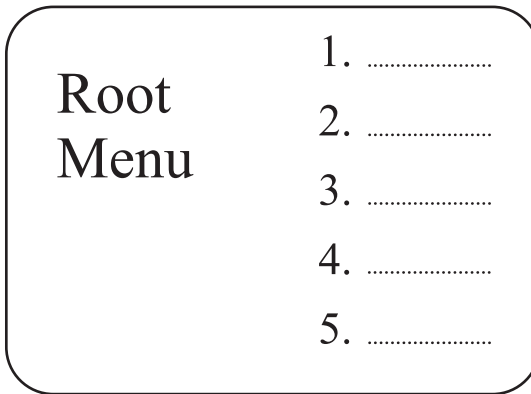

- 3 Press ►► or ◀◀ to skip to the next or previous page.
- 4 Select a title with either the number buttons or direction buttons.
- 5 Press ►► to go to the next menu.

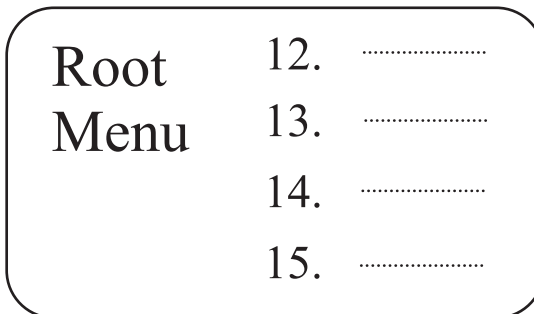

- 6 Press the number buttons to directly select a title or chapter, or press ▼ to select the title or chapter (for example, 13).

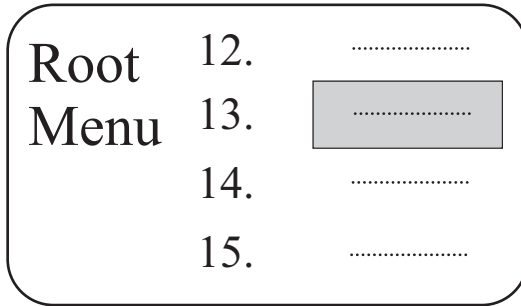

- 7 Press **OK** to start playing the chapter.
- 8 To return to the title menu, press **TOP MENU**.
Or, to return to the root menu, press **MENU**.

Using the On Screen Display (OSD)

The On Screen Display (OSD) contains many playback features. To see the OSD, press **DISPLAY** on the remote control while a disc is playing. The OSD appears across the top of the screen. Each feature is illustrated with an icon.

Press ◀ or ▶ on the remote control to select an icon on the OSD. When an icon is highlighted, press ▲ or ▼ to scroll through the choices displayed in the text box under the icons.

The OSD features are only available if the disc was created with that particular feature (for example, if you select the **Subtitle** icon, you cannot change the subtitle language unless the disc was created with subtitles).

The invalid symbol "⊘" appears on the screen when you press a button that does not have a function. If one of the icons is "grayed out," that OSD feature is not available for the disc you are playing. To close the OSD, press **DISPLAY** again.

Using the OSD when playing a DVD

DVDs have the following playback features: Title, Chapter, Audio, Subtitle, and Repeat.

Selecting a title

Some DVDs contain more than one title. For example, there might be four movies on one disc (each movie might be considered a title). Each title is divided into chapters.

To select a title:

- 1 While a disc is playing, press **DISPLAY** on the remote to open the OSD. The OSD opens.



- 2 Press ◀ or ▶ to highlight the **Title** icon.
- 3 Press ▲ or ▼ to go to the next or previous title.

Note

Some discs only have one title.

Selecting a chapter

Because DVDs use digital technology, a title can be divided into individual chapters (similar to tracks on a CD). You can skip to a specific chapter by using the Chapter feature in the OSD.

To select a chapter:

- 1 While a disc is playing, press **DISPLAY** on the remote to open the OSD. The OSD opens.



- 2 Press ◀ or ▶ to highlight the **Chapter** icon.
- 3 Press ▲ or ▼ to go to the next or previous chapter.

Note

The chapter feature will not work if the disc is not formatted with separate chapters.

You can also advance to the next chapter by pressing ▶▶ on the remote and go to the preceding chapter by pressing ◀◀ on the remote.

Changing the audio language

If the disc was created with different language tracks (recorded in different languages), you can use the OSD to temporarily change the DVD player's Audio Language setting.

To change the audio language:

- 1 While a disc is playing, press **DISPLAY** on the remote to open the OSD. The OSD opens.



- 2 Press ◀ or ▶ to highlight the **Audio** icon. The current audio language appears in the text box below the row of icons.
- 3 Press ▲ or ▼ to scroll through the audio languages that are available on the disc until the audio language you want to use appears in the text box. Audio will be played in that language.
- 4 To close the OSD, press **DISPLAY** again.

Note

The language feature only works if the disc was created with multiple audio tracks.

When you choose an audio language from the OSD, you only override the audio language setting in the DVD player's main menu temporarily.

The audio language can also be changed through the DVD player menu.

Selecting the subtitle language

If the disc was created with subtitles, you can use the OSD to change the subtitle language.

To change the subtitle language:

- 1 While a disc is playing, press **DISPLAY** on the remote to open the OSD. The OSD opens.



- 2 Press ◀ or ▶ to highlight the **Subtitle** icon.
- 3 Press ▲ or ▼ to scroll through the subtitle languages that are available on the disc until the subtitle language you want to use appears in the text box. The subtitles will be displayed in that language.

- 4 To close the OSD, press **DISPLAY** again.

Note

Changing the subtitle language with the OSD only affects the disc currently being played. When the disc is removed or the player is turned off, the subtitle language reverts to the language setting specified through the DVD player main menu.

The subtitle language can also be changed through the DVD player menu.

Using the Repeat feature

The default mode for the Repeat feature is off.

There are three Repeat options:

- All—repeats the disc that is playing
- Title—repeats the title that is playing
- Chapter—repeats the chapter that is playing

To use Repeat:

- 1 While a disc is playing, press **DISPLAY** on the remote to open the OSD. The OSD opens.



- 2 Press ◀ or ▶ to highlight the **Repeat** icon.
- 3 Press ▲ or ▼ to scroll through the Repeat options until the Repeat option you want to use appears in the text box. The selected Repeat option will loop continuously until you turn Repeat off.
- 4 Turn Repeat off by:
 - Pressing **Stop** twice.
 - Opening the OSD, selecting **Repeat**, then selecting **Off**.
 - Ejecting the disc.

Using the OSD when playing a CD

CDs have the following playback features: Track, L/R, Audio (not available) and Repeat.

To select a specific track:

- 1 While a disc is playing, press **DISPLAY** on the remote to open the OSD. The OSD opens.



- 2 Press ◀ or ▶ to highlight the **Track** icon.
- 3 Press ▲ or ▼ to scroll through the Track numbers until the track you want to use appears in the text box.

To change the audio channel output:

- 1 While a disc is playing, press **DISPLAY** on the remote to open the OSD. The OSD opens.



- 2 Press ◀ or ▶ to highlight the **L/R** icon. The audio channel choice appears in the text box.
- 3 Press ▲ or ▼ to scroll through the choices. Choices include **LEFT MONO**, **RIGHT MONO**, **MIXED MONO**, or **STEREO**. Playback continues in the mode you select.

Using the Repeat feature

The default mode for the Repeat feature is off.

There are two Repeat options for CDs:

- All—repeats the disc that is playing
- Track—repeats the track that is playing

To use Repeat:

- 1 While a disc is playing, press **DISPLAY** on the remote to open the OSD. The OSD opens.



- 2 Press ◀ or ▶ to highlight the **Repeat** icon. The Repeat option appears in the text box.

- 3 Press ▲ or ▼ to scroll through the Repeat options until the option you want is displayed in the text box.
- 4 The selected repeat option will loop continuously until you turn Repeat off.
- 5 Turn Repeat off by:
 - Pressing **Stop** twice.
 - Opening the OSD, selecting **Repeat**, then selecting **Off**.
 - Ejecting the disc.

Selecting a DVD chapter or title or a CD track

To select a DVD chapter or title or CD track:

- 1 Put the disc in the player, then press ► / II.
- 2 After your player reads the disc, press the number buttons for the title, chapter, or track you want to play.
If the title, chapter, or track has a one-digit number (for example 8), press the number (8), then press **OK**. The following screen opens.



Track08/20 00:00



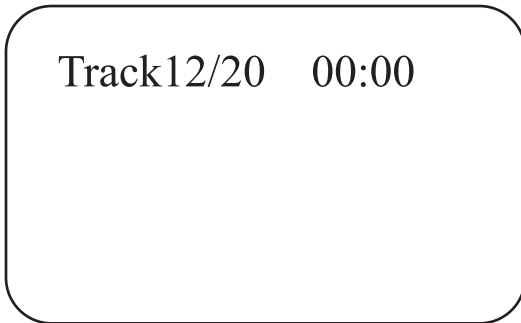

If the title, chapter, or track has a two-digit number (for example 12), press the number buttons (1 then 2), then press **OK**. The following screen opens.





Playing a disc repeatedly

You can play a DVD title, DVD chapter, CD track, or CD repeatedly.

To repeat a title or chapter on a DVD:

- To repeat a chapter, press **REPEAT** until the screen shows  Chapter . Your player repeats the chapter.
- To repeat a title, press **REPEAT** until the screen shows  Title . Your player repeats the title.
- To repeat both the chapter and title, press **REPEAT** until the screen shows  ALL . Your player repeats the chapter and title.
- To stop the repeat function, press **REPEAT** until  ALL disappears.



To repeat a track or an entire CD disc.

- To repeat a track, press **REPEAT** until the screen shows  Track . Your player repeats the current track.
- To repeat an entire disc, press **REPEAT** until the screen shows  ALL . Your player repeats the entire disc.
- To stop the repeat function, press **REPEAT** until  ALL disappears.

Repeating a section of a disc

To repeat a section of a DVD or CD:

- 1 Press **A-B** where you want to start playback. The screen shows  A .

- 2 Play the disc until you reach the point you want to return to, then press **A-B** again. The screen shows  **AB** . Your player plays the section repeatedly.
- 3 To stop the repeat function, press **A-B** again until  **AB** disappears.

Selecting the DVD audio mode

If a DVD has more than one language recorded, you can select the audio language you want to hear.

To select the DVD audio mode:

- 1 While the DVD is playing, press **AUDIO TRACK**. The screen shows:



Audio 1/2:AC 3/2.1CH

- 2 Press **AUDIO TRACK** one or more times to select the language you want.

Selecting DVD subtitles

To select DVD subtitles:

- 1 Press **SUBTITLE** one or more times to select the subtitle language you want. The screen shows the selected language.



Subtitle 01/03:ENGLISH

- 2 To turn off subtitles, press **SUBTITLE** until the screen shows **Subtitle Off**.

Note

Subtitles cannot be turned off on some discs.
Different languages may be available, depending on the disc.
If subtitles are not available, the screen shows .

Searching a disc

You can enter a time, title, or chapter number (for a DVD), or a specific track and time (for a CD) to start play from a specific point on a disc. Your player plays from the selected point.

To select a specific starting title and chapter on a DVD:

- 1 Press **SEARCH**. The screen shows:



Title 03/30 Chapter 01 /04

- 2 Press the arrow buttons to highlight a title number. The screen shows:



Title 03 /30 Chapter 01/04

- 3 Press a number button (for example, 6) to select a title number. The screen shows:



Title 06/30 Chapter 01/04

- 4 Press the arrow buttons to highlight the chapter number.
- 5 Press a number button to select the chapter number you want.
After the settings are entered, your player starts playing the DVD from the selected title and chapter.

To select a specific starting time on a DVD:

- 1 Press **SEARCH** until the screen shows:



Time : : : :

- 2 Press the number buttons to enter the hour, minute, and second for the amount of time you want to skip before your player starts playing.
After the settings are entered, your player plays the disc from the selected point.

To select a specific starting track and time on a CD:

- 1 Press a number button to select the track you want to start playing from (for example, 6). The screen shows:



Track 06/20 00:01

- 2 Press **SEARCH** to open the time search screen, then press **SEARCH** one or more times until the screen shows:



Track Go To : : :

- 3 Press the number buttons to enter the amount of time in the track that you want to skip before your player starts playing (for example, 0138). The screen shows:



Track 06/20 01:38

Your player plays the CD from the track and time you entered.

Note

You can search three ways on a CD:

Press **SEARCH** once. The screen shows **DISC GOTO --:--**. You can enter the total time you want the CD to play.

Press **SEARCH** twice. The screen shows **TRACK GOTO --:--**. You can enter the total time you want a track to play.

Press **SEARCH** three times. The screen shows **TRACK --/20**. You can enter the track number you want to go to.

Enlarging the picture

You can enlarge (zoom) the picture displayed on the screen.

To enlarge the picture:

- 1 Press **ZOOM** during playback. The screen shows:



2x

The picture is enlarged to twice its original size.

- 2 Press **ZOOM** repeatedly to select 2x, 3x, 4x, 1/2x, 1/3x, or 1/4x.
- 3 Press **◀**, **▲**, **▼**, or **▶** to move the enlarged picture.
- 4 To exit zoom mode, press **ZOOM** until the picture is normal size.

Setting parental controls

To turn parental controls on or off:

- 1 Press **SETUP**. The *SETUP MENU* opens.

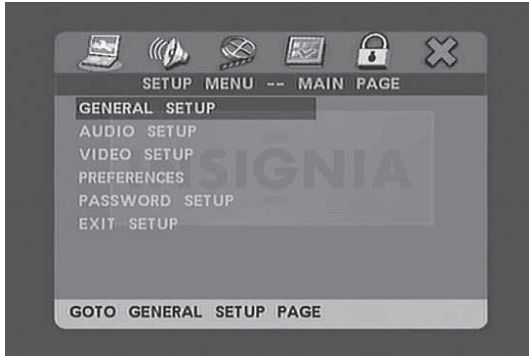

- 2 Press **▼** to select **PASSWORD SETUP**, then press **OK**. The *Password Setup Page* opens.

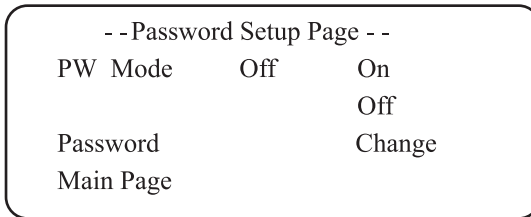

- 3 Press **▶**, then press **▼** to turn the **PW Mode Off** or **On**. If **PW Mode** is set to **On**, you are prompted to enter the password. The default password is **99999**.

To set parental controls:

- 1 Make sure that:
 - The disc tray is opened.
 - Or, the disc tray is empty.
 - Or, your player is in stop mode.

- 2 Press **SETUP**. The *SETUP MENU* opens.

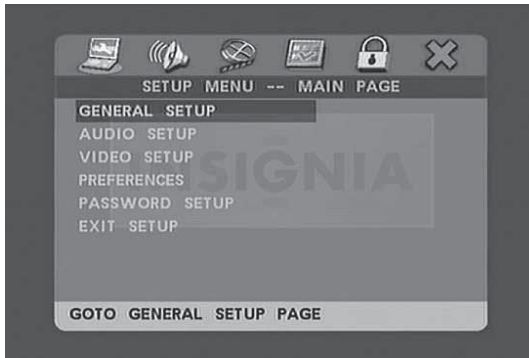

- 3 Press **▲** or **▼** to select **PREFERENCES**, then press **OK**. The *Preferences Page* opens.

Note

To select **PREFERENCES**, make sure that:

- The disc tray is open.
- Or, the disc tray is empty.
- Or, your player is in stop mode.

- 4 Press **▼** to select **Parental**. If this section is greyed, parental controls are turned on. You must first set **PW Mode** to **Off** in **PASSWORD SETUP**. The default password is **99999**.
- 5 Press **▶**, then press **▼** to select the rating you want to block. The rating you select and all higher ratings will be blocked.
- 6 Press **▶** / **||**.

Using the **SETUP MENU**

Your player has a **SETUP MENU** that lets you select settings for your player. The following is an example of how to use the **SETUP MENU** to select the Reverb Mode.

To use the **SETUP MENU**:

- 1 Press **SETUP**. The **SETUP MENU** opens.

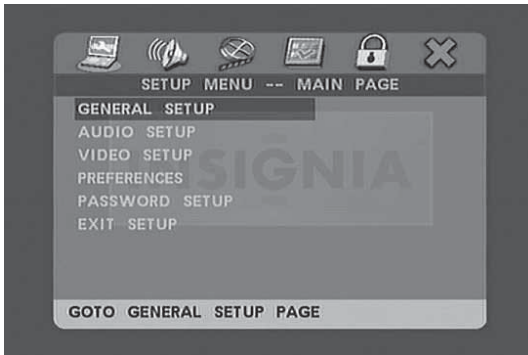

- 2 Press **▲** or **▼** to select **AUDIO SETUP**, then press **OK**. The **AUDIO SETUP PAGE** opens.



- 3 Press ▲ or ▼ to select **3D PROCESSING**, then press **OK**.

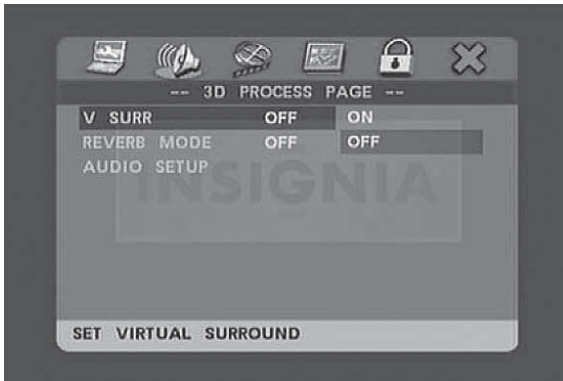

- 4 Press ▼ to select **REVERB MODE**.
5 Press ►, then press ▼ to select **LIVING ROOM**.

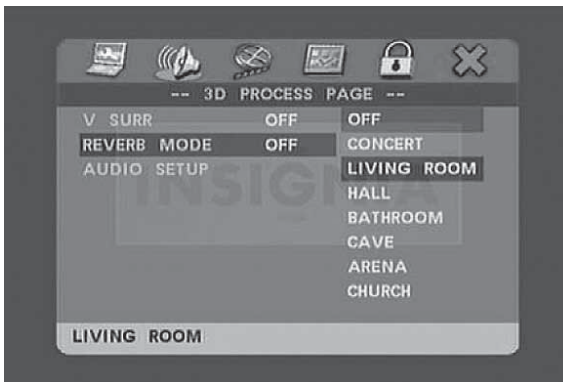

- 6 Press **OK**.

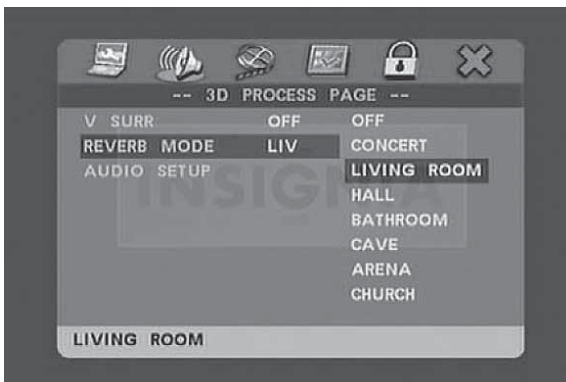

- 7 To exit, press ◀ to close the *REVERB MODE* screen.
- 8 Press ▼ to select **AUDIO SETUP**, then press **OK**.
- 9 Press ▼ to select **MAIN PAGE**, then press **OK**.
- 10 Press ▼ to select **EXIT SETUP**, then press **OK**.

OSD menus

General Setup Page

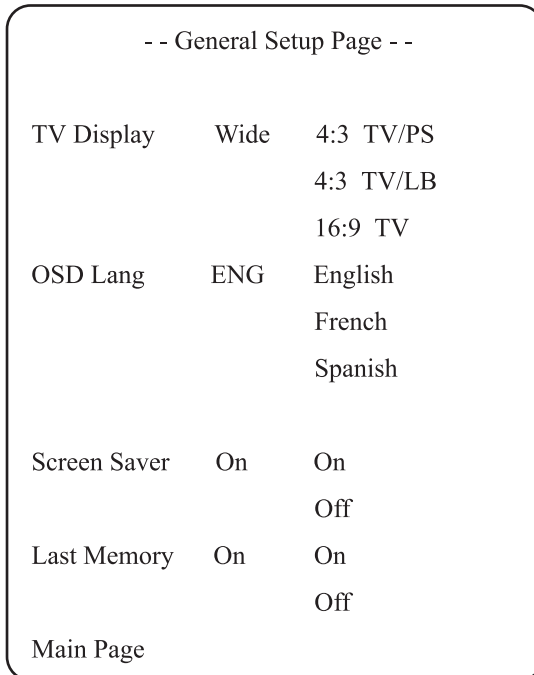

- **TV Display**—Lets you select the aspect ratio. You can select:
 - **4:3 TV/PS**—Select for normal TVs. Wide-screen images are shown on the screen with the left and right sides cut off.
 - **4:3 TV/LB**—Select for normal TVs. Wide-screen images are shown with black bars at the top and bottom of the image.
 - **16:9 TV (Wide)**—Select for wide-screen TVs.
- **OSD Lang**—Lets you select the language for the OSD. You can select **English**, **French**, or **Spanish**.

- **Screen Saver**—Lets you turn the screen saver on or off. If this option is turned on and your player is inactive for a few minutes, a screen saver appears to protect your TV from image burn-in.
- **Last Memory**—Lets you specify whether you want your player to start playback at the point on a disc where playback stopped and your player was turned off.

Audio Setup Page

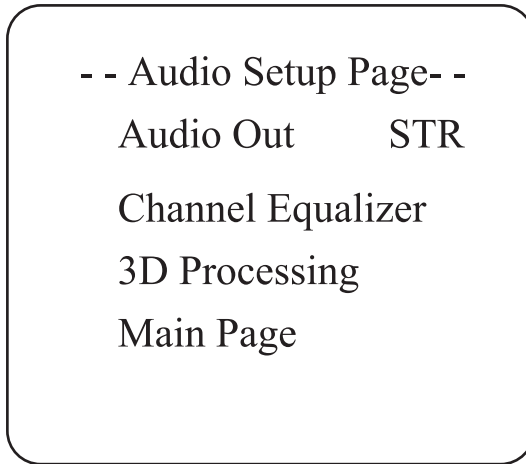

- **Audio Out**—Lets you select the audio output signal. You can select:
 - **Mixed Mono**—The output signal from a disc recorded in multi-channel format is sent to the right and left speakers.
 - **STR**—The output signal from a disc recorded in multi-channel format is converted to stereo.
- **Channel Equalizer**—Lets you select an equalizer mode. You can select **None**, **Rock**, **Pop**, **Live**, **Dance**, **Techno**, **Classic**, or **Soft**. Press the arrow buttons to select a mode, then press **▶ / II**.
- **3D Processing**—Lets you select how the audio is processed. You can select:
 - **V SURR**—Lets you turn virtual surround mode on or off.
 - **Reverb Mode**—Lets you select the reverb mode. You can select **Off**, **Concert**, **Living Room**, **Hall**, **Bathroom**, **Cave**, **Arena**, or **Church**.

Video Setup Page

-- Video Setup Page --	
Hue	00
Saturation	00
Contrast	00
Main Page	

- **Hue**—Press ◀ or ▶ to adjust the hue and confirm by pressing **OK**.
- **Saturation**—Press ◀ or ▶ to adjust the saturation and confirm by pressing **OK**.
- **Contrast**—Press ◀ or ▶ to adjust the contrast and confirm by pressing **OK**.

Password Setup Page

You use this menu to set up a parental password and to change the password.

-- Password Setup Page --		
PW Mode	Off	On
		Off
Password		Change
Main Page		

- **PW Mode**—Lets you turn the parental password feature on or off. When the parental password feature is turned on, the **Parental** option on the *Preference Page* is greyed.
- **Password**—Lets you change the parental password. The default password is **99999**. Enter the current password, enter the new password, then enter the new password again. Press **OK** to save your new password. If you forget your password, enter the default password.

Preference Page

-- Preference Page --		
TV Type	NTSC	PAL Multi NTSC
Audio	ENG	English French Chinese Japanese
Subtitle	ENG	English French Spanish Chinese Japanese Off
Disc Menu	ENG	English French Spanish Chinese Japanese
Parental	08	1 KID 2 G 3 PG 4 PG 13 5 PGR 6 R 7 NC17 8 ADULT
Default		Reset
Main Page		

- **TV Type**—Lets you select the TV's color system. You can select **PAL**, **Multi**, or **NTSC**.
- **Audio**—Lets you select the DVD audio language if the DVD has multiple audio languages.
- **Subtitle**—Lets you select the DVD subtitle language if the DVD has multiple subtitle languages.
- **Disc Menu**—Lets you select the DVD menu language if the DVD has multiple menu languages.

- **Parental**—Lets you set the rating level for DVDs. When you select a rating, that rating and all higher ratings are blocked. You need to enter your password to watch a DVD with a blocked rating. You can select **1 KID**, **2 G**, **3 PG**, **4 PG 13**, **5 PGR**, **6 R**, **7 NC17**, or **8 ADULT**.
- **Default**—Lets you reset all settings to the factory default. This option does not reset the password.

Maintaining

Handling discs

- To keep a disc clean, do not touch the play side (non-label side) of the disc.
- Do not attach paper or tape to the disc.



- Keep the disc away from direct sunlight or heat sources.
- Store the disc in a disc case after playback.

Cleaning discs

- Before playback, wipe the disc outwards from the center with clean cloth.



Cleaning pickup lens

Keep dust from the pickup lens by keeping the disc tray closed after use. If there is dust on the pickup lens, use a cleaning disc to clean them. Refer to the operating instructions of the cleaning disc you bought.

Cleaning the player/monitor

Unplug this player from the power outlet before cleaning. Do not use liquid cleaners or aerosol cleaners. Use a damp cloth for cleaning.

Troubleshooting

If you experience the following problems while using the player, this troubleshooting guide can help you.

No sound

- If your player is connected to a TV or amplifier, make sure that you operate them correctly.
- Make sure that you have selected the DVD player position on the amplifier.

No image

- Make sure that the player is connected securely.
- If the player is connected to a TV, make sure that you operate the TV correctly.
- Make sure that you set the color system correctly.

Bad sound quality

- Make sure that the audio output mode is set correctly.
- Make sure that the audio connection between the player and amplifier is correct.

Disc cannot be played

- Make sure that there is a disc in the player.
- Make sure that the disc is placed on the disc tray correctly, with the label side up.
- Make sure that the disc is clean.
- If moisture has condensed in the player, remove the disc and leave the player on for about one hour.

Remote control does not work

- Remove barriers between the remote control and the player.
- Point the remote control at the player's remote control sensor.
- Replace the battery with a new one.

TV Image rolls and has no color

- The color system of the player does not match with that of TV. Select the correct TV TYPE until TV shows normal color.

Specifications

Main player

Laser		Wavelength 650 nm
Video system		PAL/MULTI/NTSC
Frequency response		20 Hz ~ 20 KHz \pm 1dB
Signal/noise ratio		\geq 90dB
Audio distortion + noise		\leq -65dB
Channel separation		\geq 80dB
Dynamic range		\geq 80dB
Output	Audio out (analog audio)	Output level: 2V \pm 10% Load impedance: 10 K Ohms
	Video out	Output level: 1Vp-p \pm 20% Load impedance: 75 Ohm, imbalance, negative polarity
Power supply		DC 12 V 2.0 A
Allowable motion temperature		41 ~ 95°F (5 ~ 35°C)
Power consumption		\leq 24W
Dimensions		7" player - 8.43 \times 6.61 \times 1.50 inches (214 \times 168 \times 38 mm) 9" player - 9.65 \times 7.48 \times 1.38 inches (245 \times 190 \times 35 mm)
Weight		7" player - About 1.53 lbs. (0.695 kg) 9" player - About 1.962 lbs. (0.890 kg)

Extra monitor

Power supply	DC 12 V 2.0 A
Dimensions	7" player - 7.91 \times 5.91 \times 0.91 inches (201 \times 150 \times 23 mm) 9" player - 9.65 \times 6.89 \times 0.83 inches (245 \times 175 \times 21 mm)
Weight	7" player - About 0.91 lbs. (0.415 kg) 9" player - About 1.213 lbs. (0.550 kg)

Specifications subject to change without notice.

Legal notices

FCC Part 15

This device complies with Part 15 of the FCC Rules. Operation of this product is subject to the following two conditions: (1) this device may not cause harmful interference, and (2) this device must accept any interference received, including interference that may cause undesired operation.

This equipment has been tested and found to comply within the limits for a class B digital device, pursuant to Part 15 of the FCC Rules. These limits are designed to provide reasonable protection against harmful interference in a residential installation. This equipment generates, uses, and can radiate radio frequency energy and, if not installed and used in accordance with the instructions, may cause harmful interference to radio communications. However, there is no guarantee that interference will not occur in a particular installation. If this equipment does cause harmful interference to radio or television reception, which can be determined by turning the equipment off and on, the user is encouraged to try to correct the interference by one or more of the following measures:

- Reorient or relocate the receiving antenna.
- Increase the separation between the equipment and receiver.
- Connect the equipment into an outlet on a circuit different from that to which the receiver is connected.
- Consult the dealer or an experienced technician for help.

FCC warning

Changes or modifications not expressly approved by the party responsible for compliance with the FCC Rules could void the user's authority to operate this equipment.

DHHS and FDA safety certification

This product is made and tested to meet safety standards of the FCC, requirements and compliance with safety performance of the U.S. Department of Health and Human Services, and also with FDA Radiation Performance Standards 21 CFR Subchapter J.

Canada ICES-003 statement

This Class B digital apparatus complies with Canadian ICES-003.

Copyright

© 2008 Insignia. Insignia and the Insignia logo are trademarks of Best Buy Enterprise Services, Inc. Other brands and product names are trademarks or registered trademarks of their respective holders. Specifications and features are subject to change without notice or obligation.

For service and support call (877) 467-4289.

One-year limited warranty

Insignia Products ("Insignia") warrants to you, the original purchaser of this new **NS-MVDS7/9** ("Product"), that the Product shall be free of defects in the original manufacture of the material or workmanship for a period of one (1) year from the date of your purchase of the Product ("Warranty Period"). This Product must be purchased from an authorized dealer of Insignia brand products and packaged with this warranty statement. This warranty does not cover refurbished Product. If you notify Insignia during the Warranty Period of a defect covered by this warranty that requires service, terms of this warranty apply.

How long does the coverage last?

The Warranty Period lasts for 1 year (365 days) from the date you purchased the Product. The purchase date is printed on the receipt you received with the Product.

What does this warranty cover?

During the Warranty Period, if the original manufacture of the material or workmanship of the Product is determined to be defective by an authorized Insignia repair center or store personnel, Insignia will (at its sole option): (1) repair the Product with new or rebuilt parts; or (2) replace the Product at no charge with new or rebuilt comparable products or parts. Products and parts replaced under this warranty become the property of Insignia and are not returned to you. If service of Products or parts are required after the Warranty Period expires, you must pay all labor and parts charges. This warranty lasts as long as you own your Insignia Product during the Warranty Period. Warranty coverage terminates if you sell or otherwise transfer the Product.

How to obtain warranty service?

If you purchased the Product at a retail store location, take your original receipt and the Product to the store you purchased it from. Make sure that you place the Product in its original packaging or packaging that provides the same amount of protection as the original packaging. If you purchased the Product from an online web site, mail your original receipt and the Product to the address listed on the web site. Make sure that you put the Product in its original packaging or packaging that provides the same amount of protection as the original packaging.

To obtain in-home warranty service for a television with a screen 25 inches or larger, call 1-888-BESTBUY. Call agents will diagnose and correct the issue over the phone or will have an Insignia-approved repair person dispatched to your home.

Where is the warranty valid?

This warranty is valid only to the original purchaser of the product in the United States and Canada.

What does the warranty not cover?

This warranty does not cover:

- Customer instruction
- Installation
- Set up adjustments
- Cosmetic damage
- Damage due to acts of God, such as lightning strikes
- Accident
- Misuse
- Abuse
- Negligence
- Commercial use

- Modification of any part of the Product, including the antenna
- Plasma display panel damaged by static (non-moving) images applied for lengthy periods (burn-in).

This warranty also does not cover:

- Damage due to incorrect operation or maintenance
- Connection to an incorrect voltage supply
- Attempted repair by anyone other than a facility authorized by Insignia to service the Product
- Products sold as is or with all faults
- Consumables, such as fuses or batteries
- Products where the factory applied serial number has been altered or removed

REPAIR REPLACEMENT AS PROVIDED UNDER THIS WARRANTY IS YOUR EXCLUSIVE REMEDY. INSIGNIA SHALL NOT BE LIABLE FOR ANY INCIDENTAL OR CONSEQUENTIAL DAMAGES FOR THE BREACH OF ANY EXPRESS OR IMPLIED WARRANTY ON THIS PRODUCT, INCLUDING, BUT NOT LIMITED TO, LOST DATA, LOSS OF USE OF YOUR PRODUCT, LOST BUSINESS OR LOST PROFITS. INSIGNIA PRODUCTS MAKES NO OTHER EXPRESS WARRANTIES WITH RESPECT TO THE PRODUCT, ALL EXPRESS AND IMPLIED WARRANTIES FOR THE PRODUCT, INCLUDING, BUT NOT LIMITED TO, ANY IMPLIED WARRANTIES OF AND CONDITIONS OF MERCHANTABILITY AND FITNESS FOR A PARTICULAR PURPOSE, ARE LIMITED IN DURATION TO THE WARRANTY PERIOD SET FORTH ABOVE AND NO WARRANTIES, WHETHER EXPRESS OR IMPLIED, WILL APPLY AFTER THE WARRANTY PERIOD. SOME STATES, PROVINCES AND JURISDICTIONS DO NOT ALLOW LIMITATIONS ON HOW LONG AN IMPLIED WARRANTY LASTS, SO THE ABOVE LIMITATION MAY NOT APPLY TO YOU. THIS WARRANTY GIVES YOU SPECIFIC LEGAL RIGHTS, AND YOU MAY ALSO HAVE OTHER RIGHTS, WHICH VARY FROM STATE TO STATE OR PROVINCE TO PROVINCE.

Contact Insignia:

For customer service please call 1-877-467-4289

www.insignia-products.com

INSIGNIA™ is a trademark of Best Buy Enterprise Services, Inc.

Distributed by Best Buy Purchasing, LLC.

Insignia, 7601 Penn Avenue South, Richfield, Minnesota, U.S.A.

INSIGNIA™

www.insignia-products.com

(877) 467-4289

Distributed by Best Buy Purchasing, LLC
7601 Penn Avenue South, Richfield, MN USA 55423-3645
© 2008 Best Buy Enterprise Services, Inc.

All rights reserved. INSIGNIA is a trademark of Best Buy Enterprise Services, Inc. Registered in some countries.
All other products and brand names are trademarks of their respective owners.

ENGLISH
08-1222